

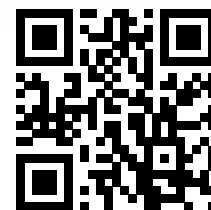





EZ7

<http://tiny.cc/EZ7seriesEN>

 TIPPING LOAD 1800 kg	 BATTERY CAPACITY 16,5 kWh	 SPEED 12 km/h	 FLOW RATE 35 l/min	 LIFT HEIGHT 2,9 m
--	--	---	--	---

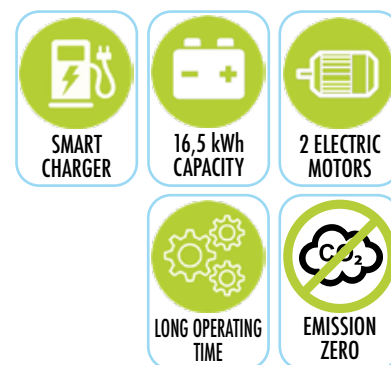

Model	EZ 7
Transmission	Hydrostatic
Drive speed (max.) ⁽¹⁾	12 km/h (7.5 mph)
Aux. hydraulics oil flow	35 l/min (9.3 GPM)
Max. lifting height	2,90 m (114 in)
Tipping load, max ⁽²⁾	1800 kg (3968 lbs)
Lifting capacity straight ⁽³⁾	1440 kg (3175 lbs)
Lifting capacity fully articulated ⁽⁴⁾	1224 kg (2700 lbs)
Breakout force / 50 cm	1700 kg (3748 lbs)
Pushing force (c)	2050 kgf (kp)
Specific ground pressure (w/standard tires)	955 kg/m ² (196 lbs/sqft)
Turning radius: inside/outside	825/2090 mm (32.5/82.3 in)
Standard tires (Tractor profile)	26X12.00-12
Weight	1860 kg (4100 lbs)
Product Code	C962020

Electric system and battery

Battery type	Lead Acid
Battery capacity	16,5 kWh
Electric motors	2
Charging system	Integrated charger
Charger type	Sealed single-phase
Charger Input Voltage	110 - 230 ± 10% VAC
Charger Input Frequency	50 ÷ 60 Hz
Charger Absorbed Current	Max. 14 A
Charging Current (230 VAC)	Max. 50 A
Charging Current (120 VAC)	Max. 25 A
Charger plug type	Schuko, CEE 7/7
Charger Protection	Output short-circuit, Inverse polarity
Charger Operating temp.	- 30° to + 70° C

Daily work cycle in hours ⁽⁵⁾

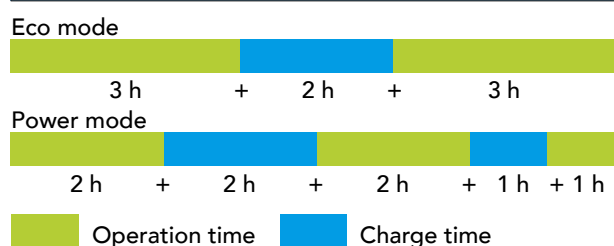

⁽¹⁾ Maximum speed that can be achieved with the largest diameter tires available, on a flat surface and machine without attachments.

⁽²⁾ Maximum load that can be lifted just off the ground when the machine is straight, with rear weights and boom not extended. Weight of attachment included.

⁽³⁾ Machine straight, with rear weights and boom not extended. Weight of attachment is included. (80% of tipping load).

⁽⁴⁾ Machine fully articulated, with rear weights and boom not extended. Weight of attachment is included.

⁽⁵⁾ The operation time of machine varies highly depending on the type of work it is performing.

EZ7 - FEATURES

- Twin Motors Single Ended Circuits
- Lead Acid Battery
- Integrated Smart Battery Charger
- Zero Emission
- Low Noise
- Braking Energy Recovery System
- 4WD hydrostatic Direct Drive motors, proportional servo control
- DBS (Dynamic Block System)
- Self-levelling double-H telescopic boom
- 4-functions joystick
- Multi-disk parking brake
- LCD graphic display with programmed service (tachometer, hour meter, battery gauge, light indicator and other 14 indicators)
- 2 front led working light
- Ergonomic full adjustable suspension seat with armrests and seat belt
- Radial piston high efficiency and heavy duty wheel motors
- Hydraulic multiconnector
- ROPS-FOPS Level I

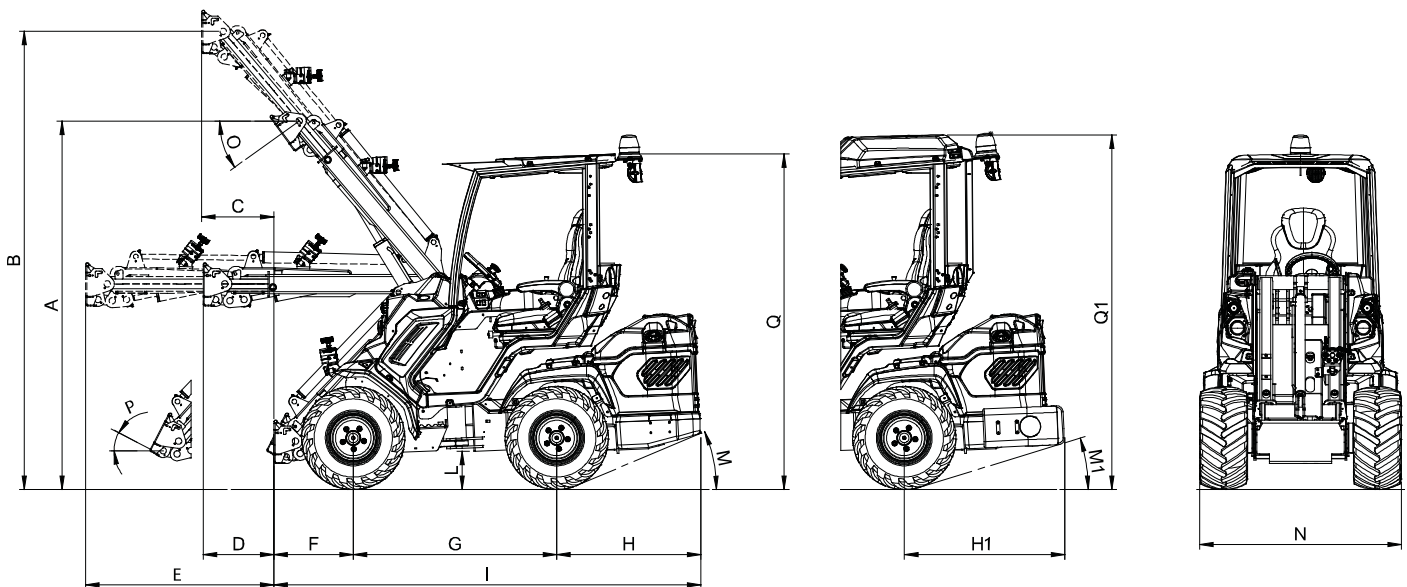

DIMENSIONS (mm / in)

A - Pivot point height (not extended boom)	2280 / 89.7	I - Machine length	2690 / 105.9
B - Pivot point height (extended boom)	2900 / 114	L - Ground clearance	210 / 8.3
C - Outreach with lifted boom (extended)	455 / 17.9	M - Angle of departure	18°
D - Outreach with orizontal boom (not extended)	445 / 17.5	M1 - Angle of departure (with rear weights)	16°
E - Outreach with orizontal boom (extended)	1185 / 46.6	N - Max width (with standard tires)	1280 / 50.4
F - Front length	500 / 19.7	O - Dump angle	36°
G - Wheelbase	1280 / 50.4	P - Rollback angle	29°
H - Rear length	910 / 35.8	Q - Height (with standard tires)	2040 / 80.3
H1 - Rear length with rear weights	1010 / 39.7		

Tires size	Width (N)	Height (Q)
23X8.50-12	1070 mm (42.2 in)	2020 mm (79.5 in)
23X10.50-12 ET-25	1130 mm (44.5 in)	2020 mm (79.5 in)
26X12.00-12 ET-50	1280 mm (50.4 in)	2040 mm (80.3 in)
27X8.50-15	1070 mm (42.1 in)	2080 mm (81.9 in)
27X10.50-15	1150 mm (45.3 in)	2080 mm (81.9 in)

EZ SERIES - OPTIONS

Options	Code
Attachment coupling plate for rear mounting	C880031
Backup warning beeper	C883021
Beacon light	C883039
Biodegradable oil	C883007
Driver area cover	C880049
Fast charging station (only EZ8)	C883806
Flat face coupling kit	C880221
Floating boom valve	C883011
High comfort seat	C883006
Left protection bar for operator	C883020
Multifunction joystick	C883703
Plexiglass back window (smart cabin)	C883035
Plexiglass right side (smart cabin)	C883034
Plexiglass windscreen (smart cabin)	C883000
Rear bull bar with side extensions	C883036
Rear weights 180 kg (90 kg + 90 kg) / 396 lbs (198lbs + 198 lbs)	C880054
Skid tires 27x10.50-15, set of 4	C884012
Skid tires 27x8.50-15, set of 4	C884011
Snow chains for wheel	see page 69
Tie down bracket on wheel hub, set of 4	C883065
Tractor tires 23x10.50-12 ET-25, set of 4	C884007
Tractor tires 23x8.50-12, set of 4	C884005
Trailer coupling	C885014
Turf tires 23x10.50-12 ET-25, set of 4	C884008
Turf tires 23x8.50-12, set of 4	C884006
Turf tires 26x12.00-12 ET-50, set of 4	C884010
Wheel spacer 10 mm (0.4 in), set of 4 (max. 1 pcs for wheel)	C880090
Wheel spacer 55 mm (2.2 in), set of 4	C885010